

The Atacama Desert Trek: Outcomes

Deepak Bapna, Eric Rollins, John Murphy, Mark Maimone, William Whittaker

Field Robotics Center, The Robotics Institute
Carnegie Mellon University
Pittsburgh PA 15213, USA

email: deepak@frc.ri.cmu.edu
Phone: +1-412-268-7086; Fax: +1-412-268-5895

David Wettergreen
NASA Ames Research Center
Moffett Field, CA 94035, USA

email: dsw@artemis.arc.nasa.gov

Abstract

In June and July 1997, Nomad, a planetary-relevant mobile robot, traversed more than 220 kilometers across the barren Atacama Desert in Chile, exploring a landscape analogous to the surfaces of the Moon and Mars. In this unprecedented demonstration, Nomad operated both autonomously and under the control of operators thousands of kilometers away, addressing issues of robot configuration, communication, position estimation, and navigation in rugged, natural terrain. The field experiment also served to test technologies for remote geological investigation, paving the way for new exploration strategies on Earth and beyond. Finally, by combining safeguarded teleoperation with panoramic visualization and a novel user interface, the Atacama Desert Trek provided the general public a compelling interactive experience an opportunity to remotely drive an exploratory robot.

Nomad's performance in the Atacama Desert Trek set a new benchmark in high performance robotics operations relevant to terrestrial and planetary exploration. This paper presents an overview of the experiment, describes technologies key to Nomad's success, and discusses outcomes and implications.

1 Overview

The primary objective of the Atacama Desert Trek was to develop, demonstrate, and evaluate a robot capable of long distance, long duration planetary exploration ([8], [10]). Meeting this objective, **Nomad** (Figure 1) operated for six weeks and navigated more than 220 km across the



Figure 1: Nomad (2.4m x 2.4m x 2.4m)

Atacama Desert in South America while under the control of operators in North America.

The Desert Trek addressed issues vital to remote planetary exploration:

Locomotion. Nomad demonstrated the viability of four-wheel drive, four-wheel steer locomotion as well as an innovative transforming chassis appropriate for planetary exploration.

Imaging. Nomad carried a panospheric camera that generated rich imagery with an ultrawide field of view. The experiment proved the advantages of this camera over traditional imaging for teleoperation and remote geology and laid the groundwork for a new era of *telepresence*, i.e., real time remote experience.

Communication. Nomad achieved high data rate communication over extended range by actively pointing a high gain antenna. The experiment addressed issues in

pointing from mobile robots, demonstrated the feasibility of this scenario, and evaluated its effectiveness.

Position Estimation. In addition to traditional sensor-based methodologies (odometry, inclinometers, a gyrocompass, and the Global Positioning System [GPS]), the Desert Trek demonstrated new visual position estimation technology, using panoramic skyline images to determine position on an existing terrain map.

Safeguarded Teleoperation. Traditional robotic teleoperation requires a continuous communication link as well as a human operator to identify and avoid obstacles. Nomad's onboard sensors modelled terrain, and its navigation computing enabled safeguarded teleoperation driving. This experiment benchmarked the potential of such capabilities for aiding planetary exploration.

Remote Science. Nomad carried sensors for remote geology and meteorite search. The panoramic imagery allowed scientists in North America to efficiently localize Nomad and identify gross geology. The high resolution imagery from science cameras enabled characterization of rocks and features with accuracy never before achieved. Nomad also used patterned navigation with position registration and onboard sensors to search for meteorites.

In addition to advancing robotics technologies for planetary exploration, the Desert Trek involved mass public participation in robotic exploration for the first time. Nomad's rich, interactive user interface and safeguarded teleoperation presented novice operators with the opportunity to operate Nomad safely from remote control centers at the Carnegie Science Center in Pittsburgh, NASA Ames in Mountain View, and Entel headquarters in Santiago, Chile. Images and data from Nomad were also immediately available on the Internet.

2 Site Description

Located in northern Chile, the Atacama Desert (Figure 2) proved to be an ideal setting for demonstration of robotic capabilities relevant to planetary exploration. Its heavily eroded topography, rocky terrain and loose sands combine to create a landscape similar to that found on the Moon, Mars and other planets.

The selected site, Domeyko, a mountain range just west of the Salar de Atacama, is considered to be the most rugged part of the desert. This site provided varied topography suitable for antenna placement, views of the surrounding landscape, and operational access. The Atacama's location within the same time zone as eastern United States also simplified coordination of operations.

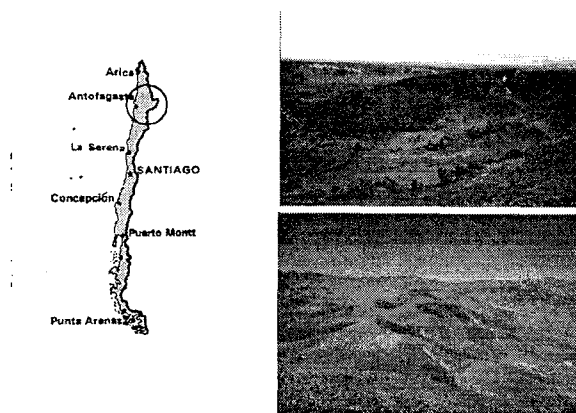

Figure 2: The Atacama Desert

3 Nomad

In the desert, Nomad demonstrated that it is responsive to the challenges of planetary locomotion, navigation, remote imagery and communications. Weighing 725kg, Nomad features four wheel drive/four wheel steering, with a unique transforming chassis that deploys to improve stability and propulsion over variable terrain. Table 1 presents specifications for Nomad.

Nomad was self-sufficient, with onboard sensing, navigation, and planning for safeguarded and autonomous driving. Virtual Dashboard, a operator interface developed by NASA Ames, combined with high bandwidth communication and imagery from panospheric and conventional cameras to provide a rich interactive experience for remote drivers and observers.

The following sections describe the primary onboard technologies and demonstration results, as well as the operator interface, science, and control scenarios.

4 Locomotion

For terrestrial and planetary exploration, robot locomotion must have traction, steering, and suspension responsive to terrain marked by craters, rocks, and loose sands and soils. Nomad's four wheel drive, four wheel steer locomotion and transforming chassis provide the appropriate balance of complexity and capability for effective traction and mobility.

Nomad traversed the Atacama's varied and difficult terrain using four aluminum wheels with cleats along the circumference. In-wheel propulsion, independent of steering and suspension, achieved reliability through simplicity.

Nomad's chassis (Figure 3) expands, compacts, and steers by driving a pair of four-bar mechanisms on either side of the robot. In the "deployed" mode, Nomad's

Item	Value/Comments
Physical	
Mass	725 kg
Power Consumption	3500W max.
Size	1.8m x 1.8m x 2.4m stowed 2.4m x 2.4m x 2.4m deployed
Locomotion	
Wheel Size	76.2cm diameter x 50.8cm width
Static Stability	$\pm 35^\circ$
Obstacle	0.5m height
Speed	0.5m/s maximum 0.3m/s average
Imaging	
Panospheric Camera	1k x 1k color at 6Hz
Compression	60:1; Wavelet compression
Communication	
Data Rate	1.54Mbps (Total)
Equipment	Wireless ethernet bridge using high gain antenna Low bandwidth radio as backup
Sensors	
Position Estimation Sensors	GPS, gyrocompass, wheel encoders, sky-line positioning from imagery
Navigation Sensors	Stereo cameras
Science	
Weather Report	Weather sensor (temperature, wind velocity, humidity)
Remote Geology	2 pairs of stereo cameras mounted on a pan/tilt mechanism for remote geology
Meteorite Search	- eddy current sensor - Two 3-axis magnetometer
Computing	
Real Time Computer	50MHz 68040 & 40MHz 68030 running VxWorks
Imaging Computer	200MHz Dual Pentium Pro running NT
Navigation Computer	133MHz Pentium running Linux
Science Computer	133MHz Pentium running Linux
Operation Modes	
Safeguarded Teleoperation	Remote driver, onboard safety enabled
Autonomous	No human intervention
Direct Teleoperation	Remote driver, onboard safety disabled

Table 1: Nomad Specifications

stability and propulsion over variable terrain are drastically improved. An averaging bar linking right and left sides facilitates body posture averaging for smooth driving motion, and ensures consistent, reliable operation of sensitive onboard sensors and processors.

During the trek, Nomad travelled more than 220 km with a maximum single-day traverse of more than 24 km. It scaled down-slopes as steep as 38° , up-slopes as steep as 22° , cross-slopes of 33° , and surmounted discrete obstacles as high as 56 cm. It also validated its

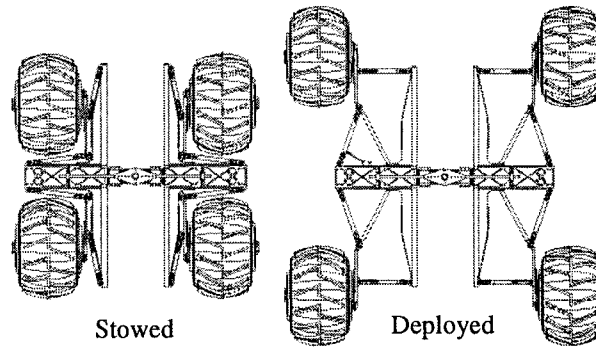

Figure 3: Transforming Chassis

transforming chassis, varying its footprint between 1.8x1.8 m and 2.4x2.4 m more than 100 times.

5 Visualization System

The traditional cameras used in robot teleoperation have a limited field of view compared to human vision. Nomad's panospheric camera¹ conveys spherical images of the complete horizon to provide operators and observers a full breadth of coverage for viewing and driving in planetary terrain [5].

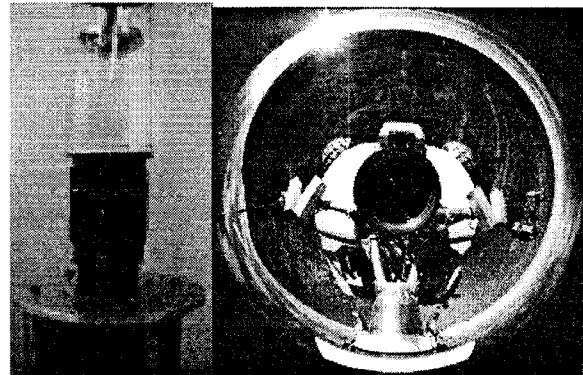

Figure 4: Panospheric Camera & an Image

Nomad used the panospheric camera (Figure 4) as its primary camera. Mounted above the center of Nomad's "hood," the camera produced a 360° image with a field of view that extended from straight down to 42° above the horizon. Acquired at 4 Hz, panospheric images were compressed using a dual Pentium-Pro computer and commercial wavelet compression software. Transmission to the control sites was accomplished by using a multi-casted UDP packetizing scheme. At the control sites, the imagery was decompressed and then processed into a format suitable for display. For the Carnegie Science Center display, a

1. The original concept of panospheric imaging evolved from the Canadian Defense Research Program at DRES from their work in armored vehicle guidance.

200° horizontal and 60° vertical immersive dome screen, the panospheric image was texture mapped onto the inside of a sphere. With the viewpoint at the center of the sphere, the operator could look around in any direction and see the environment from Nomad's perspective. As new images arrived, the designated field of view was updated with smooth and natural motions.

The Atacama Desert Trek was the first time that immersive imagery has been used for remote teleoperation in natural environments. During the course of the trek more than one million panospheric images were captured, transmitted and displayed at about 1 Hz. The experiment not only proved the viability of panospheric video for robotic teleoperation and telescience, but also empirically demonstrated an improvement in operator anticipation of and extrication from unterrainable conditions.

6 High Bandwidth Communication

Field robots commonly use omnidirectional antennas for communication with remote control stations. This scheme restricts the bandwidth (nominally < 100 kbps) and range (nominally < 1 km) due to the limited power available onboard the robot ([1], [2]). To achieve high data rate communication over extended range, Nomad used an actively pointed high gain antenna.

The communication path for the desert trek is outlined in Figure 5. The robot carried a wireless ethernet

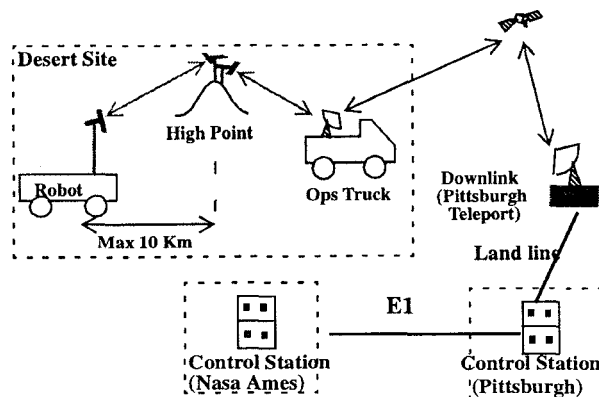

Figure 5: Communication Overview

bridge and a radio for communicating with a repeater station located at high elevation. The wireless bridge provided the high data rate required to transmit panospheric imagery; however, this configuration necessitated Nomad's high gain antenna and pointing device for orienting the antenna. The low bandwidth radio was a backup radio that could carry all status/command/control information and limited imagery in

case of failure of the pointing mechanism. Using another wireless bridge, communication was achieved between the repeater station and the Operations truck. From a 1.8m Ku-band dish on the Operations truck, the information was transmitted to a satellite, where it was cross-strapped to a C-Band transponder and transmitted to the U.S and Chile. This information was downlinked at receiver stations in Pittsburgh and Santiago and then sent to control stations via land lines.

Custom designed for Nomad, the antenna pointing device is a balanced mechanism (Figure 6) that can steer the antenna at high slew rates up to 60°/s. This compensated for vehicle motion by orienting the onboard antenna towards a relay station located 0-10 km away. To achieve accurate pointing control, the necessary position estimates were generated using Differential GPS (DGPS), compass, inclinometers and encoder data.

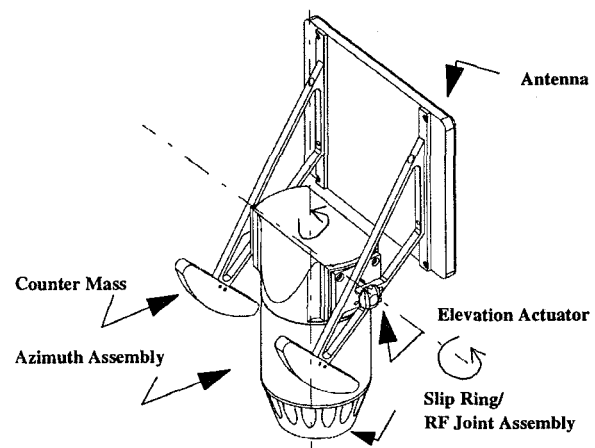

Figure 6: Antenna Pointing Mechanism

During the trek, Nomad communicated with a relay station up to 11 km away at data rates up to 1.5 Mbps. This is the first time this order of range and data rate has been achieved from a mobile robot.

7 Position Estimation

Estimation of robot position and orientation was accomplished by fusing data from a range of sources. The primary source was a pair of GPS units that were configured in a differential mode to enable resolution on the order of 20 cm. Local updates were provided by odometry from wheel encoder velocity data. Rover orientation data were provided by a gyrocompass/inclinometer suite, which gave magnetic north heading

as well as roll and pitch information to a resolution of 0.1° and an accuracy of 1° .

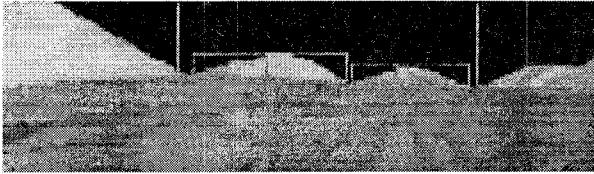

Figure 7: Skyline Views Based on Position Estimation

The trek also demonstrated skyline position estimation [3] in which position was estimated by matching visual skylines with a digital elevation map. The visual skyline was extracted automatically from 360° panoramas generated by an automatic registration algorithm. The posterior probability for the rover position was calculated for every cell in the map; the highest value of posterior probability was the estimate. Skyline position estimation tested in the Atacama obtained exceptional accuracy of 180 to 360 m on a 1600 square km search area.

8 Safeguarded Teleoperation

The vast distances and inherent communication delays encountered in planetary exploration present a fundamental technical barrier to direct teleoperation of planetary robots. Typically, a human operator is responsible for robot safety, and the robot must pause while a new image is transmitted between each move. Nomad mitigated this limitation by using onboard sensors and computing to autonomously distinguish between safe and dangerous routes. Nearby obstacles were modelled and mapped using stereo cameras, and registered using onboard position estimation. Nomad's knowledge of its environment enabled two unique driving modes: safeguarded teleoperation and autonomy.

During the Atacama Desert Trek, safeguarded teleoperation gave remote operators direct steering control over the robot, as long as the commanded direction was deemed safe by Nomad's onboard sensors. If the human operator directed Nomad onto a dangerous path or toward an obstacle, the safeguarding system overrode that command and forced Nomad to either stop or to steer around the obstacle. Figure 8 illustrates the information considered by the onboard safeguarding system; range data produced by the stereo cameras were projected into an overhead view of an elevation map, and all possible forward paths were evaluated. Potential obstacles were considered for each path, and only when a path was found to be free of obstacles was Nomad allowed to move in that direction [6]. This processing occurred in real time, with new maps generated once

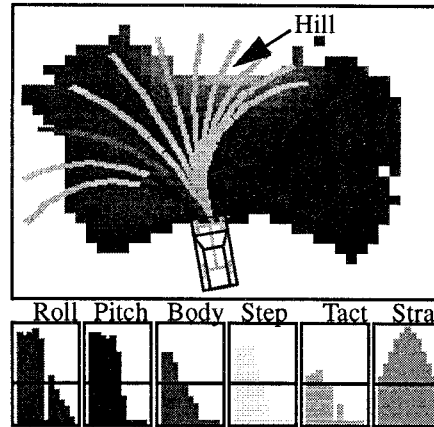

Figure 8: Onboard Obstacle Detection

every two seconds, so the obstacle detection was always one step ahead of the remote operator. As long as the stereo range data was good, Nomad could immediately determine whether it was safe to proceed in a given direction.

Nomad also performed precision patterned search using GPS information to map an area. There were two primary modes of patterned search: "farming" and waypoint navigation. In the farming mode Nomad was dynamically controlled over the satellite link as it executed a search of a rectangular area. Nomad would drive back and forth in evenly spaced rows, completely covering the search area along the way. This type of control provided the capability to deploy a sensor and exhaustively search an area, a technique critical to future terrestrial surveys for meteorites. In the waypoint navigation mode, Nomad visited an ordered list of GPS coordinates. All processing and control were performed onboard the vehicle, with lists of goal points provided by the operator or auto-generator. Once Nomad reached a goal location, it immediately started driving toward the next one. Both farming and waypoint navigation used only position information as input to the controlling process.

During the trek, Nomad traversed 21 km autonomously at up to 43 cm/sec with built-in automatic obstacle detection. Another 7 km of the remote control driving was in safeguarded mode with obstacle detection. To the 221 km total, Patterned search contributed 63 km, of which 6 km were driven using waypoint navigation. The stereo vision sensors maintained their calibration, ran successfully for up to nine hours each day, and were effectively untouched during the duration of field operations.

9 Operator Interface

Nomad's operator interface, called the Virtual Dashboard, was simple and intuitive to use, provided compelling interaction with the remote robot explorer, and resulted in more efficient and effective science operations. The main objectives were to: simplify assessment of current robot state; reduce the number of operators and the required skill level; impart an accurate understanding of robot's environment; and operate as effectively telepresent, as if physically present with the robot.

Throughout the Desert Trek, the Virtual Dashboard provided a clear visualization of the robot's state in recognizable graphical and numeric formats. The robot's position was plotted on aerial images, and the pose was rendered in 3-D with real-time updates. An operator could quickly assess Nomad's condition and command the robot, using a mouse to dictate the direction and speed and to point cameras. This improved efficiency and resulted in more rapid site exploration.

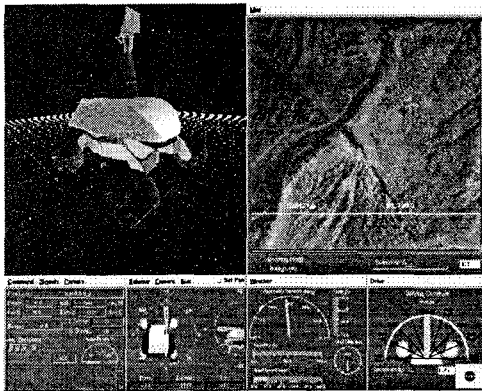

Figure 9: Virtual Dashboard

With Nomad's Virtual Dashboard, the operator could command individual components, drive the robot, or set a direction for the autonomous navigation system. A compass indicated current direction. The virtual environment display (shown in the upper left of Figure 9) provided a perspective view of the robot. All robot motions were rendered in real time. With the freedom to "fly around" the view and observe the robot as it moved, operators had increased situational awareness and driving efficiency.

10 Science Field Experiment

Nomad incorporated instruments for experiments in telescience, specifically for geological investigation. In addition to the panspheric camera, it carried stereo color cameras, with resolution matched to the human

foveal region (about 0.3 milliradians per pixel), mounted on a pan-tilt device. An eddy current sensor (metal detector) and two 3-axis magnetometers were carried for use in finding ferrous materials, like meteorites. The objectives for the science field experiments were to: provide realistic desert experience for operators through high-quality imagery and a virtual environment interface; evaluate near-term planetary missions (to the Moon, Mars, and Antarctica) by training scientists, identifying control environment appropriateness, developing exploration strategies, and refining science team organization; evaluate various imaging techniques: panspheric imaging, foveal-resolution stereo imaging, image mosaicing, and textured terrain models; and understand the reasons for correct and incorrect scientific interpretation by collecting ground-truth and carefully examining scientists' methods and conclusions.

Scientists conducted experiments that were simulations of remote operations on the Moon and Mars and in Antarctica. Two Mars mission simulations provided training for site characterization and sample caching operations. The site characterization exercise, in which scientists tried to correctly characterize the climate, geology and evidence of past life, was conducted without panspheric or aerial imagery, in analog to the Mars Pathfinder mission. Scientists collaborated to analyze images from the science cameras, resulting in a slow but thorough examination of the site. The sample caching exercise utilized all available imagery and resulted in nearly four times the area covered with a number of distinct rock types selected as samples.

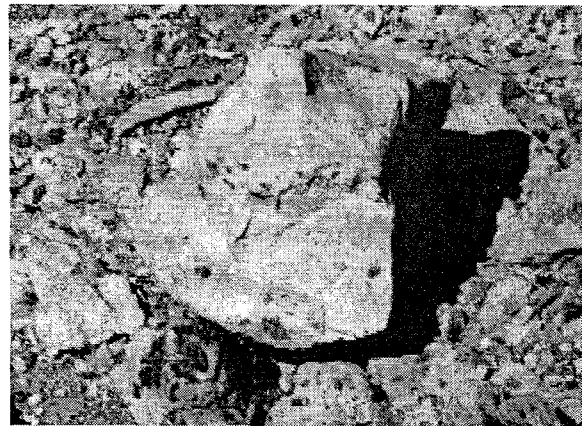

Figure 10: A Sample Science Image

In the Lunar mission simulation, remote scientists attempted to perform geology-on-the-fly, in which they assessed trafficability and surveyed gross geology while keeping the rover in motion 75% of the time. This mode of operation is appropriate for long-distance exploration or for traverse between sites of scientific interest. In a

record for remote exploration, Nomad traversed 1.3 kilometers and examined 10 science sites. During this test scientists also made the surprising discovery of a Jurassic fossil bed

For the Antarctic test, the objective was to evaluate the feasibility of searching visually and magnetically for meteorites with a remotely-controlled robot. On-site geologists prepared a 100m-by-5m area test area with surface and buried meteorites. Nomad made a patterned search, while remote geologists looked for indicative rock features. Of three visible meteorites geologists correctly identified one meteorite (and correctly rejected two meteorite-looking rocks). While searching with visual and magnetic sensors, they found that the readily identifiable magnetic signature helped to localize iron meteorites and significantly improved chance of discovery (three meteorites were found).

Lastly, experiments were conducted to determine the usefulness of the panospheric camera when operating with time delay. With a time-delay of 15 minutes (average for Mars), and both with and without panospheric imagery, scientists performed the same tasks: approach a science site, image sufficient features to provide an interpretation, and repeat. With panospheric imagery, fewer uninformative images were taken and twice as much area was examined.

Initial indication of the science field experiment is that the ability to continually see all around the robot provides scientists with a sense of the remote site that has been previously lacking. Nomad's panospheric imagery substantially benefits situational awareness and accelerates site exploration. It helps to localize the robot, understand the surroundings and plan traverses. Panospheric imagery clearly improves efficiency- it enables scientists to assess the gross geology and quickly focus on key indicators. This has benefit when operating with time delay.

11 Stateside and Public Participation

During operations in South America, Nomad was controlled from the Carnegie Science Center and NASA Ames in North America and a site in Santiago, Chile in South America. The science center's Electric Horizon theatre displayed panospheric imagery on a 6 m diameter spherical section covering 200° of azimuth and 60° of elevation. The theatre capacity was 33 with two shows presented every hour. During the 250 hours of public participation, over 12,000 science center visitors were involved in the control of Nomad. From the audience, 32 participants were able to jointly control the direction of view around Nomad on the theatre screen.

Also, during each hour an average of four visitors controlled the operation (steering and velocity) of Nomad. Approximately 20 km of Nomad's trek were under the control of science center visitors. The total distance driven by "novice" operators during the Atacama Desert Trek was approximately 65 km. In addition, imagery and robot status were available in real time on the Internet, and tens of thousands of "page-hits" were recorded with over a thousand responses via email, phone and through public relations contacts.

Carnegie Science Center also housed several kiosks that described the direct link between robotics and space exploration, a relationship heightened during this summer by the Pathfinder/Sojourner Mars landing. Kiosks also illustrated the innovative technologies utilized on Nomad, the science performed during the Desert Trek, and information about the Atacama Desert and Chile.

In conjunction with the CMU Art department and the Robotics Institute, the Centre for Metahuman Exploration created RoverTV. During three hour-long shows, Nomad's panospheric imagery was broadcast on a Pittsburgh cable channel, and viewers were able to call in and use their touch-tone phone to send pan/tilt and steering commands to the robot. There were approximately 20 operators who experienced Nomad in this manner, and the success of these broadcasts suggests a completely new approach to public interaction and robotic exploration.

The Nomad experience was a landmark with respect to public participation. For the first time the general public had the opportunity to take control of a multi-million dollar NASA robotics system and become a "Telenaut." Over 50,000 visitors to the Carnegie Science Center browsed the information kiosks. Over 200 members of the Young Astronaut program interacted with Nomad, and eight high school students participated in an extensive Nomad experience as part of their Science Academy Summer.

12 Outcomes

The Atacama Desert Trek demonstrated capabilities for high performance planetary exploration by mobile robots. The outcomes of the trek are profiled in Table 2.

The Atacama Desert Trek executed the longest off-road robotic traverse in history. Breakthrough technologies relevant to locomotion, panospheric and immersive visualization, high data rate communications, position estimation, safeguarded teleoperation and autonomous driving, and remote geology were demonstrated. Beyond technical objectives, the Atacama

<i>Item</i>	<i>Comments</i>
Remote Operations	- 201 km from the science center (101 km from drivers, 63 km of patterned search and 21 km of autonomy) - 18 km from NASA Ames - 2 km from Santiago
Locomotion	- 223.5 km during the trek - 24.22 km max. in a day - Approx. 100 chassis openings/closings
Panospheric Camera	- 40,000 bytes/image - 20,000-30,000 images/day - 1 million images at 1 Hz or better
Communication	- 1.5 Mbps mobile network - Record distance of 11 km achieved between Nomad and relay station - 16 hrs/day (nominal) of link for 2 months
Safeguarded Teleoperation/ Autonomous Driving	- 21 km autonomous traverse at 43cm/s - 6 km safeguarded teleops at 43 cm/s
Position Estimation using Skyline	180-300 m accuracy in 1600 sq. km area
Science	- Simulated 4 planetary analog missions - Longest robotics traverse of 1.31 km in a day while performing science - Detected planted meteorites using cameras, a metal detector and magnetometers.
Public Participation	- Approx. 50,000 people visited Nomad kiosks at the CSC - Approx. 12,000 people visited Electric Horizon theatre at science center - More than 200 novice drivers and scientists drove Nomad from Carnegie Science Center/NASA Ames/Santiago - Pittsburgh TV viewers drove Nomad using phones while watching imagery on TV - Kiosks at the science center showed videos detailing various technologies - Robotic classes offered at the science center during trek duration

Table 2: Operations and Experiments

Desert Trek has set a new standard for operational and public outreach for robotic exploration experience.

Acknowledgments

This project was supported by NASA through grants NAGW-3863 and NAGW-1175.

The work presented in this paper is a collaborative effort of many people and several organizations. Nomad's success was the result of its team and the cooperation from various governmental agencies and private companies. The Nomad team consisted of members from CMU, NASA Ames and the University of Iowa. While CMU was lead on the project, NASA Ames developed the user interface and led the science

experiments. The GROK lab at the University of Iowa developed the software for panospheric display.

Special thanks are due to friends of Nomad [11]-Aironet, BEI, Carnegie Science Center, Center for Metahuman Exploration (CMU), Centro de Estudios Espaciales (Universidad de Chile), City of Pittsburgh, Coasin, Codelco, Dalsa, Embassy of the United States in Santiago, Entel, FINDS, Fourth Planet, Fuerza Aerea de Chile, Heinz Endowment, Human Computer Interaction Institute (CMU), IOWA Space Grant Consortium, Intel, Learning Curve Toys, LunaCorp, Mesta Electronics, Mekanismos, NASA Internet, The North Face, Pittsburgh Foundation, Pontifica Universidad Catolica de Chile, Real-Time Innovations, Inc., Sandia National Laboratories, Silicon Graphics, Spitz, Inc., Summus, Ltd. Trimble Navigation, Ltd., University Catolica del Norte, University of Pittsburgh, ViRtogo, Inc.

References

- [1] Bapna, D., Teza, J.P., Rollins, E., and Whittaker, W., "An Innovative High Bandwidth Communication System for Mobile Robots", 27th International Conference on Environmental Systems, Lake Tahoe, Nevada, July 14-17, 1997, SAE Technical Series, Paper 972488.
- [2] Bapna, D.; Martin, M.; and Whittaker, W. "Earth-Moon Communication from a Moving Lunar Rover," *Proceedings of the 42nd International Instrumentation Symposium*, San Diego, CA, May 5-9, 1996, pp613-622.
- [3] Cozman, F.G.; and Krotkov, E., "Automatic Mountain Detection and Pose Estimation for Teleoperation of Lunar Rovers", Proc. of the International Conference on Robotics and Automation, pp. 2452-2457, Albuquerque, New Mexico, 1997.
- [4] Hine, B., Piguat, L., Fong, T., Hontalas P., and Nygren, E., "VEVI: A Virtual Environment Teleoperations Interface for Planetary Exploration," *Proceedings of SAE 25th International Conference on Environmental Systems*, San Diego, USA, July 1995.
- [5] Murphy, J. "Application of Panospheric Imaging to a Teleoperated Lunar Rover," *IEEE Intl. Conf on Systems, Man and Cybernetics*. 1995. Vol 4
- [6] Simmons, R., et. al., "Experience with Rover Navigation for Lunar-Like Terrain", *Proceedings of the Conference on Intelligent Robots and Systems (IROS)*, Pittsburgh PA, 1995.
- [7] Thomas, H., Hine, B., and Garvey, J., "Kilauea: A Terrestrial Analogue for Studying the Use of Rovers in Planetary Science," *Proceedings of the Space Science Institute*, May 1995.
- [8] Whittaker, R., Bapna, D., Maimone, M., and Rollins, E., "Atacama Desert Trek: A Planetary Analog Field Experiment", *Proceedings of i-SAIRAS 97*, Tokyo, Japan, July 14-16, 1997, pp355-360.
- [9] Web: <http://img.arc.nasa.gov/marsokhod/marsokhod.html>
- [10] Web: <http://www.ri.cmu.edu/atacama-trek>
- [11] <http://www.ri.cmu.edu/atacama-trek/FON/FON.html>